

STB - Quick Guide

Packaging List:

Digital Decoder Digi JC22 x 1

Battery AAA x 2

Remote Control Unit x 1

HDMI cable x 1

User Manual x 1

Power Adapter x 1

Install Guide

If you are using the decoder for the first time or restoring the factory settings, please perform the steps below.

λ Select OSD Language: Romanian/Spanish/Portuguese/
Italian/Dutch/French/German/English

λ Select Country: Romania/Spain/Portugal/Italy/Belgium

λ Start channel search: OK/Cancel

Notice

Default password is 0000

Front Panel

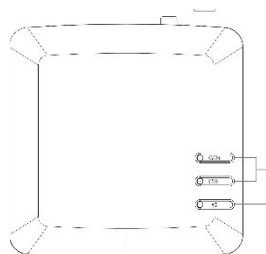

1. CH+/CH- Change the channels

2. Standby/Power ON

Rear Panel/Left side:

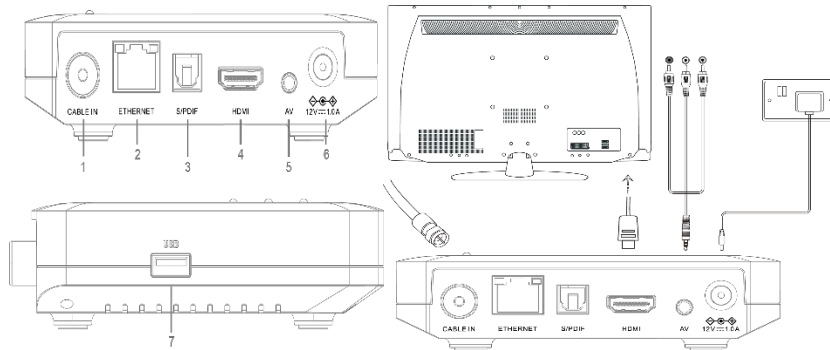

1. CABLE IN Connect the signal cable.
2. ETHERNET Connect the Ethernet (internet) cable.
3. S/PDIF Optical interface for digital audio output.
4. HDMI HDMI port for TV display.
5. AV Composite video & audio output.
6. DC IN Connect the power adapter.
7. USB USB 2.0, 5V, 500mA Max.

Remote Control Unit

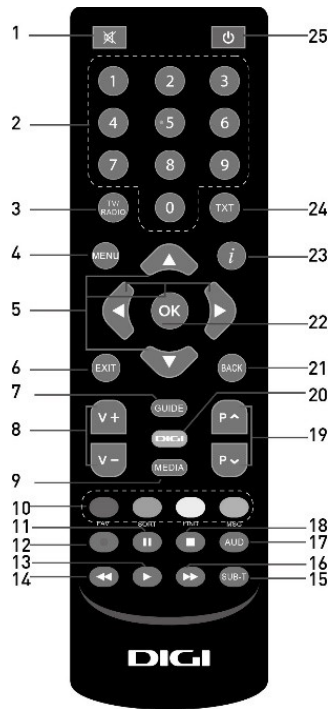

1. Mute/Unmute
2. Digits for channel selection.
3. Switch TV mode/Radio mode
4. Main menu
5. Arrow keys for menu navigation
6. Exit to view mode
7. EPG information
8. Volume controls.
9. View Media files
10. Function keys
11. Pause Key
12. Record Key
13. Play Key
14. Rewind Key
15. Subtitle menu
16. Fast forward Key
17. Audio menu
18. Stop Key

19. Channel UP/DOWN
20. DIGI portal
21. Back to the previous channel
or previous menu.
22. Confirm or select.
23. View information of the
current channel
24. Teletext
25. Power On/OFF

Connecting Up

Connecting Network

This section introduces the network connection methods for STB. Select one method to connect according to the on-site conditions.

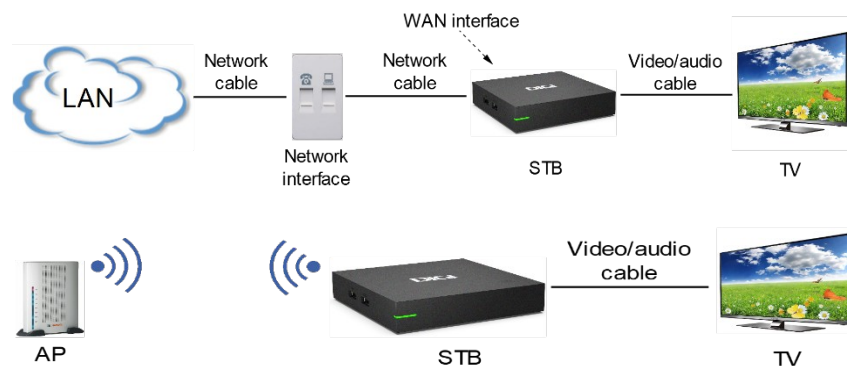

Video and Audio Connections

Steps

- Connecting 3.5 mm RCA AV Output Interface
1. Connect the **R** and **L** interfaces on the TV to the corresponding interfaces with the AV cables.
 2. Connect the **AV** interface on the TV with the AV cable (yellow), as shown in the follow figure.

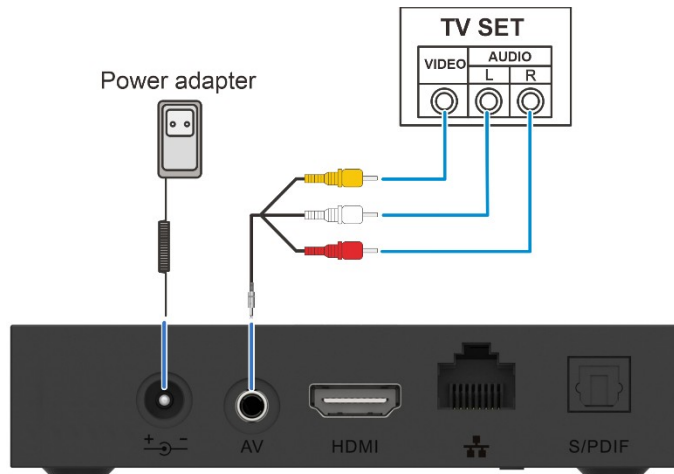

- Connecting High Definition Interface

Connect the HDMI interface on the STB and TV with HDMI cable, as shown in the follow figure.

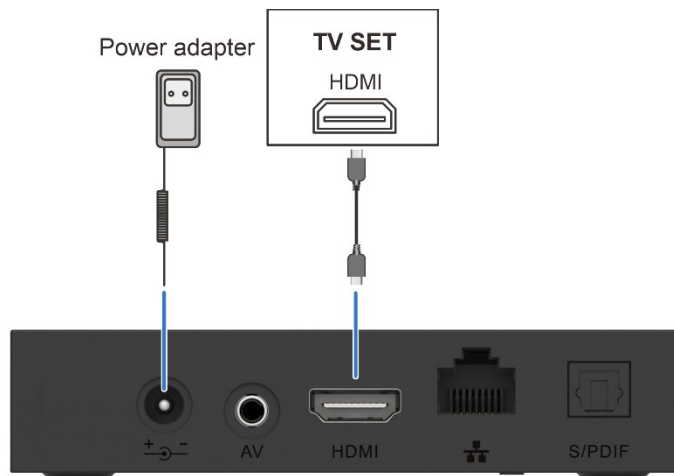

Power ON

Steps

1. Ensure that all cables are connected correctly.
2. Install the power cable to STB using the power adapter and to AC power source.
3. Ensure that all other devices are plugged in and receiving power.
4. Turn on the TV.

—END OF STEPS—

Upgrade

The STB can connect to the server on each power-on and check whether an upgrade is required. If so, the upgrade starts at once, which normally takes about ten minutes. Do not perform any operations during this period.

Operation Guide:



Switch between the standby and working state



Press the key on the remote control to enter the Launcher homepage.



Press direction keys (up, down, left, and right) on the remote control to select an item.





Press **OK** key to confirm the selection. Apăsați lung tasta pentru a începe preluarea vocală, indicatorul se aprinde; eliberați tasta

pentru a opri preluarea vocală și pentru a stinge indicatorul luminos.

Volume Operations:



Turn up/ down volume of STB.

- a. Long press at the  (OK) +  button for 3 seconds (indicator light flashes), until pairing successful. Indicator light will turn to be always on for 3 seconds and then turns off.